



Manufacturer & Master Distributor  
of Non-Threaded Fasteners  
& Grease Fittings

# EVEN

# BIGGER

# NEWS

# IN TAPER PINS

G.L. HUYETT NOW HAS MORE LENGTHS IN SIZES #11, #12, #13, AND #14 IN STOCK.



[huyett.com](http://huyett.com) | 785-392-3017 | [sales@huyett.com](mailto:sales@huyett.com)

**ISO** 9001:2008  
CERTIFIED



# TAPER PINS

Taper pins are solid cylindrical pins with a uniform taper that runs the entire length of the pin. They are held in place with dry friction making them easy to install and cost effective.

## PREFIXES

- TP** = CARBON STEEL, PLAIN  
**TPS** = STAINLESS STEEL, PLAIN

## PIN SIZES

- 11** = (B) OUTSIDE DIAMETER: .860"  
**12** = (B) OUTSIDE DIAMETER: 1.032"  
**13** = (B) OUTSIDE DIAMETER: 1.241"  
**14** = (B) OUTSIDE DIAMETER: 1.523"

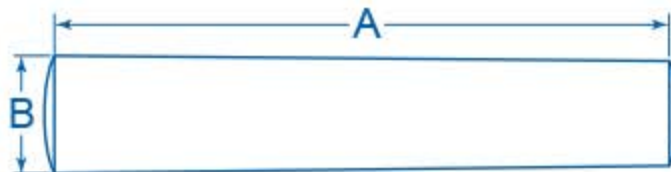

Item Number	(A) Overall Length
PREFIX-SIZE-1000	1.000" (1)
PREFIX-SIZE-1250	1.250" (1-1/4)
PREFIX-SIZE-1500	1.500" (1-1/2)
PREFIX-SIZE-1750	1.750" (1-3/4)
PREFIX-SIZE-2000	2.000" (2)
PREFIX-SIZE-2250	2.250" (2-1/4)
PREFIX-SIZE-2500	2.500" (2-1/2)
PREFIX-SIZE-2750	2.750" (2-3/4)
PREFIX-SIZE-3000	3.000" (3)
PREFIX-SIZE-3250	3.250" (3-1/4)

Item Number	(A) Overall Length
PREFIX-SIZE-3500	3.500" (3-1/2)
PREFIX-SIZE-3750	3.750" (3-3/4)
PREFIX-SIZE-4000	4.000" (4)
PREFIX-SIZE-4250	4.250" (4-1/4)
PREFIX-SIZE-4500	4.500" (4-1/2)
PREFIX-SIZE-4750	4.750" (4-3/4)
PREFIX-SIZE-5000	5.000" (5)
PREFIX-SIZE-5250	5.250" (5-1/4)
PREFIX-SIZE-5500	5.500" (5-1/2)
PREFIX-SIZE-5750	5.750" (5-3/4)

Item Number	(A) Overall Length
PREFIX-SIZE-6000	6.000" (6)
PREFIX-SIZE-6500	6.500" (6-1/2)
PREFIX-SIZE-7000	7.000" (7)
PREFIX-SIZE-7500	7.500" (7-1/2)
PREFIX-SIZE-8000	8.000" (8)
PREFIX-SIZE-9000	9.000" (9)
PREFIX-SIZE-10000	10.000" (10)
PREFIX-SIZE-11000	11.000" (11)
PREFIX-SIZE-12000	12.000" (12)

TO ORDER, REPLACE PREFIX WITH YOUR CHOICE: TP • TPS AND SELECT A PIN SIZE: 11 • 12 • 13 • 14

## APPLICATIONS

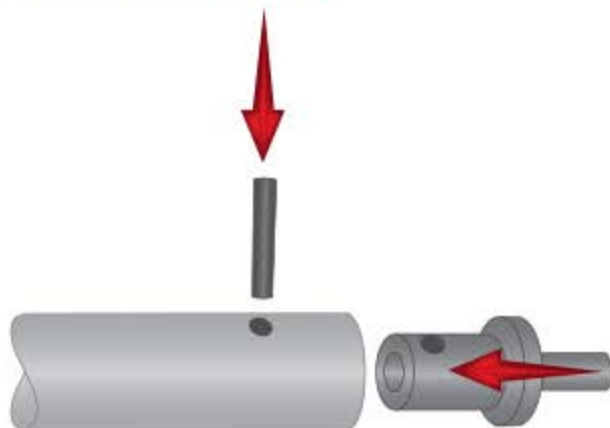

TAPER PINS ARE USED TO ALIGN AND HOLD A DEVICE IN INJECTION ASSEMBLY COMPONENTS.

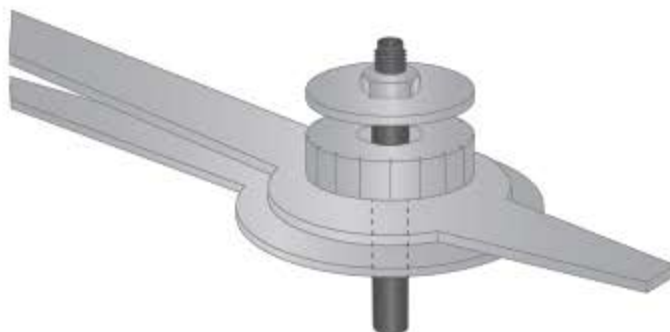

EXTERNAL THREADED TAPER PINS ARE USED TO HOLD A CLOCK HAND MECHANISM TOGETHER.



TAPERS ARE EXPRESSED IN TERMS OF RISE OVER RUN. IN OTHER WORDS, THE AMOUNT OF TAPER IS STATED PER LINEAR UNITS OF MEASURE. A 1/4" TAPER PER FOOT MEANS THAT FOR EVERY 12" IN LINEAR DISTANCE (RUN) THE THICKNESS OF THE PART (RISE) DECREASES BY 0.25".

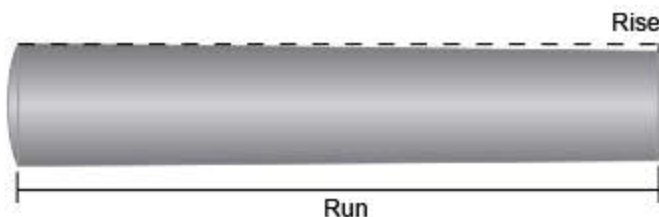

Visit [Huyett.com](http://Huyett.com) for low minimums, great prices, and easy ordering.



# EXTERNAL THREADED TAPER PINS

The diameters of threaded taper pins allow them to be used interchangeably with standard taper pins. Threaded taper pins are .002" smaller on the

larger end diameter than standard taper pins to allow the threaded taper pin to be inserted approximately .093" (3/32) deeper into the taper-reamed hole. The

large end of the threaded taper pin is recessed below the surface that allows the nut to bear on the surface when tightened to pull the pin out.



## PREFIXES

- TPT** = CARBON STEEL, PLAIN
- TPT6** = 300 SERIES STAINLESS STEEL, PLAIN
- TPTN** = CARBON STEEL, PLAIN WITH HEX NUT
- TPT6N** = 300 SERIES STAINLESS STEEL, PLAIN WITH HEX NUT

UNF THREAD TYPE ON ALL VERSIONS.

Material/Finish combinations may not be available in all sizes.

## PIN SIZES

- 11** = (A) OUTSIDE DIAMETER: .858"  
(C) HEAD LENGTH: 1.125" (1-1/8)  
THREAD SIZE: 3/4"  
THREAD PITCH: 16  
USE WITH NUT: HXN-0750
- 12** = (A) OUTSIDE DIAMETER: 1.030"  
(C) HEAD LENGTH: 1.281" (1-9/32)  
THREAD SIZE: 7/8"  
THREAD PITCH: 14  
USE WITH NUT: HXN-0875
- 13** = (A) OUTSIDE DIAMETER: 1.239"  
(C) HEAD LENGTH: 1.281" (1-9/32)  
THREAD SIZE: 7/8"  
THREAD PITCH: 14  
USE WITH NUT: HXN-0875
- 14** = (A) OUTSIDE DIAMETER: 1.521"  
(C) HEAD LENGTH: 1.438" (1-7/16)  
THREAD SIZE: 1-1/8"  
THREAD PITCH: 12  
USE WITH NUT: HXN-9125

Item Number	(B) Effective Length
PREFIX-SIZE-1000	1.000" (1)
PREFIX-SIZE-1250	1.250" (1-1/4)
PREFIX-SIZE-1500	1.500" (1-1/2)
PREFIX-SIZE-1750	1.750" (1-3/4)
PREFIX-SIZE-2000	2.000" (2)
PREFIX-SIZE-2250	2.250" (2-1/4)
PREFIX-SIZE-2500	2.500" (2-1/2)
PREFIX-SIZE-2750	2.750" (2-3/4)
PREFIX-SIZE-3000	3.000" (3)
PREFIX-SIZE-3250	3.250" (3-1/4)
PREFIX-SIZE-3500	3.500" (3-1/2)
PREFIX-SIZE-3750	3.750" (3-3/4)
PREFIX-SIZE-4000	4.000" (4)
PREFIX-SIZE-4250	4.250" (4-1/4)
PREFIX-SIZE-4500	4.500" (4-1/2)
PREFIX-SIZE-4750	4.750" (4-3/4)
PREFIX-SIZE-5000	5.000" (5)
PREFIX-SIZE-5250	5.250" (5-1/4)
PREFIX-SIZE-5500	5.500" (5-1/2)
PREFIX-SIZE-5750	5.750" (5-3/4)
PREFIX-SIZE-6000	6.000" (6)
PREFIX-SIZE-6500	6.500" (6-1/2)
PREFIX-SIZE-7000	7.000" (7)
PREFIX-SIZE-7500	7.500" (7-1/2)
PREFIX-SIZE-8000	8.000" (8)
PREFIX-SIZE-9000	9.000" (9)
PREFIX-SIZE-10000	10.000" (10)

TO ORDER, REPLACE PREFIX WITH YOUR CHOICE:

TPT • TPT6 • TPTN • TPT6N

AND SELECT A PIN SIZE: 11 • 12 • 13 • 14



THREADED TAPER PINS ARE USED IN BLIND HOLES WHERE IT IS NOT POSSIBLE TO REMOVE THE TAPER PIN BY DRIVING IT OUT FROM THE SMALL END. REMOVAL IS ACHIEVED BY SCREWING A NUT DOWN ONTO THE THREADS PULLING THE TAPER PIN OUT.

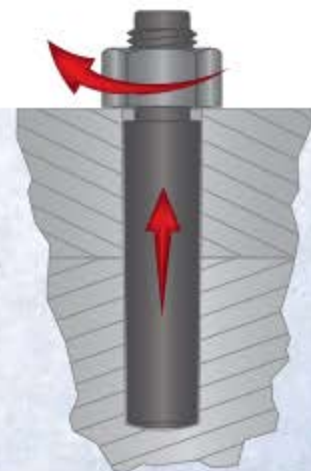



# INSTALLATION & REMOVAL

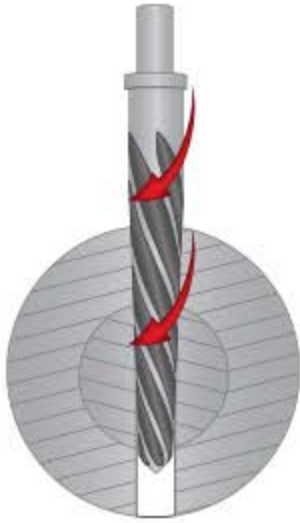

IF A HELICALLY FLUTED TAPER REAMER IS USED, THE DIAMETER OF THE SMALL END\* OF THE PIN IS THE SIZE FOR THE THROUGH DRILL

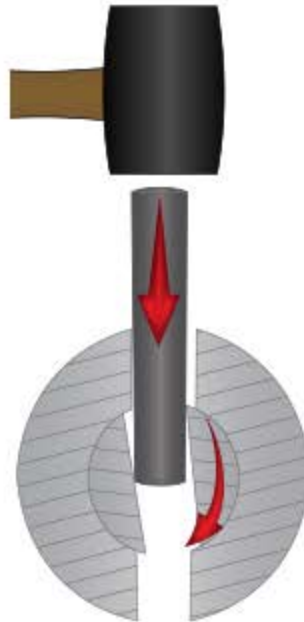

TAPER PINS ARE USED AS POSITIONING COMPONENTS FOR TRANSMITTING LOW TORQUES.



TO REMOVE, SIMPLY POUND A PUNCH OR DRIVE TOOL INTO THE SMALL END.

\*Taper pins are called out by a size and length. The size refers to the diameter of the large end. To get the diameter of the small end, multiply the length by .02083 and subtract from the decimal size of the large end.

**More than 2,000 taper pins available in sizes #7/0 - #14.**

## ALSO AVAILABLE FROM G.L. HUYETT



Dowel Pins  
Standard and Oversized

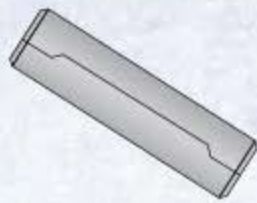

Ground Hollow  
Dowel Pins



Pullout  
Dowel Pins



Flat Vent  
Dowel Pins

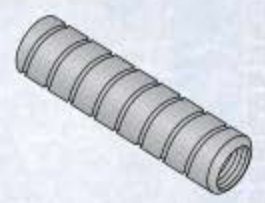

Spiral Grooved  
Dowel Pins



Slotted  
Spring Pins



Coiled Spring Pins  
Light, Standard, and  
Heavy Duty



Toothed  
Spring Pins



Grooved Pins  
Imperial and Metric  
Types A, C, E, G, H, and U

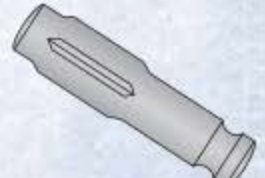

Visit [Huyett.com](http://Huyett.com) for low minimums, great prices, and easy ordering.